



1610 READY SPACE[®]

Dual Technology Carpet Cleaner



Setup

See Backside



Restorative Cleaning

ReadySpace Cleaning

Before Use

1



ReadySpace Cleaning



2

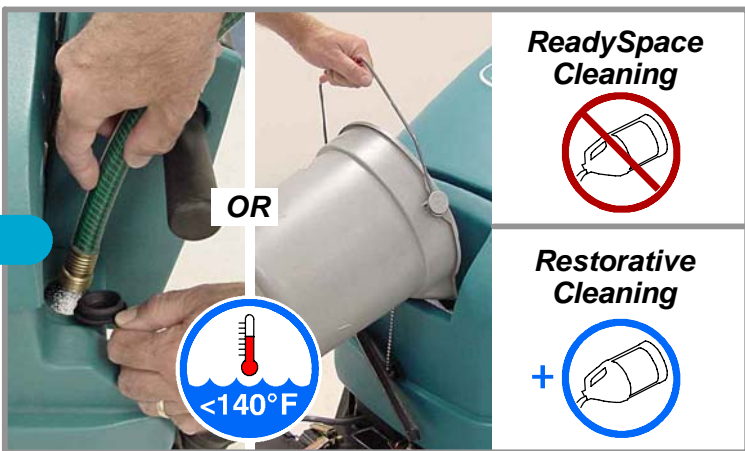

OR



ReadySpace Cleaning



Restorative Cleaning

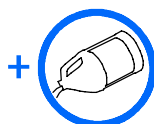

Operate

3

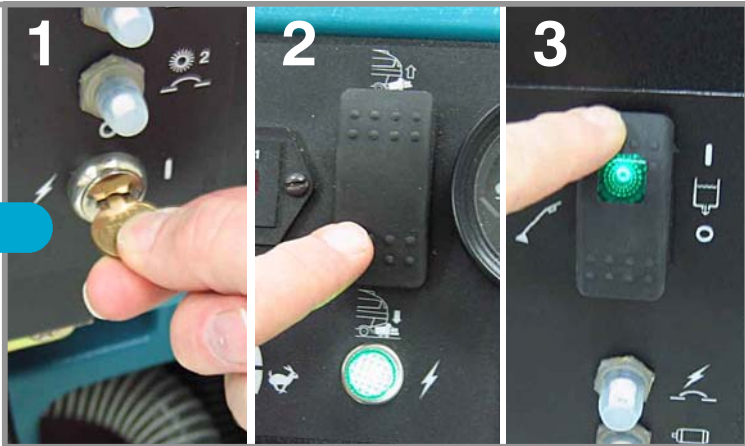

1

2

3

4



Rev

Fwd

ReadySpace: 100 ft per minute
Restorative: 50 ft per minute

5



ReadySpace Cleaning

Restorative Cleaning

After Use

6

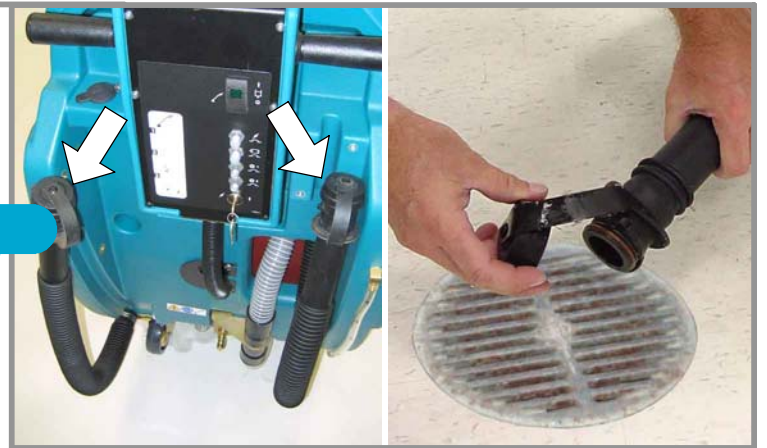

7



8

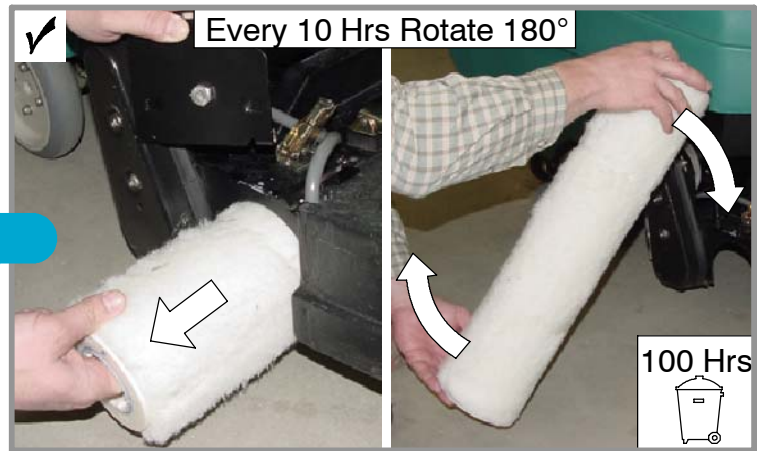

Every 10 Hrs Rotate 180°

100 Hrs

9

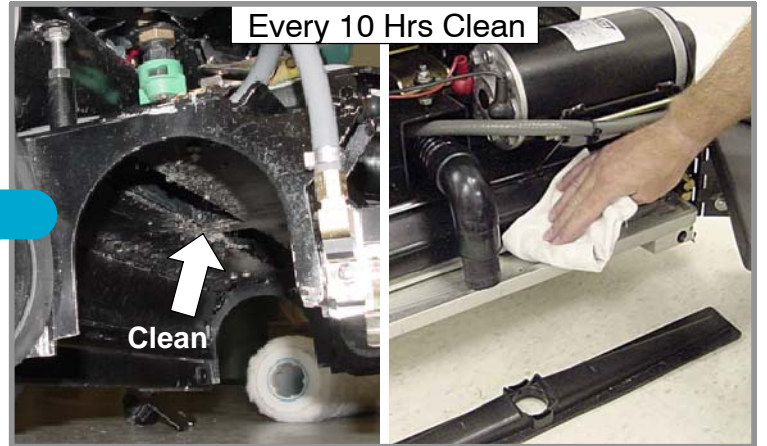

Every 10 Hrs Clean

Clean

Clean Front & Rear Vacuum Shoe

10

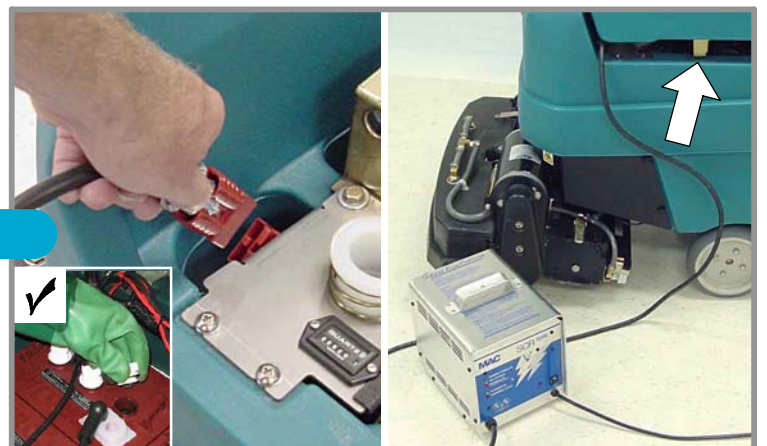

Setup

ReadySpace Cleaning

FOR SAFETY: Remove key from machine before performing setup procedure.

1. Install the two *ReadySpace* Rollers.
2. Install rear *ReadySpace* Vacuum Shoe.
3. Connect the two Solution Flush Lines to Vacuum Shoe.
4. Connect Vacuum Tube to Vacuum Shoe.
5. Connect Vacuum Hose to Vacuum Tube.

Equipment Needed:

- 1) Two *ReadySpace* Rollers
- 2) Rear *ReadySpace* Vacuum Shoe
- 3) 6 mm Hex Head Tool (supplied with machine)

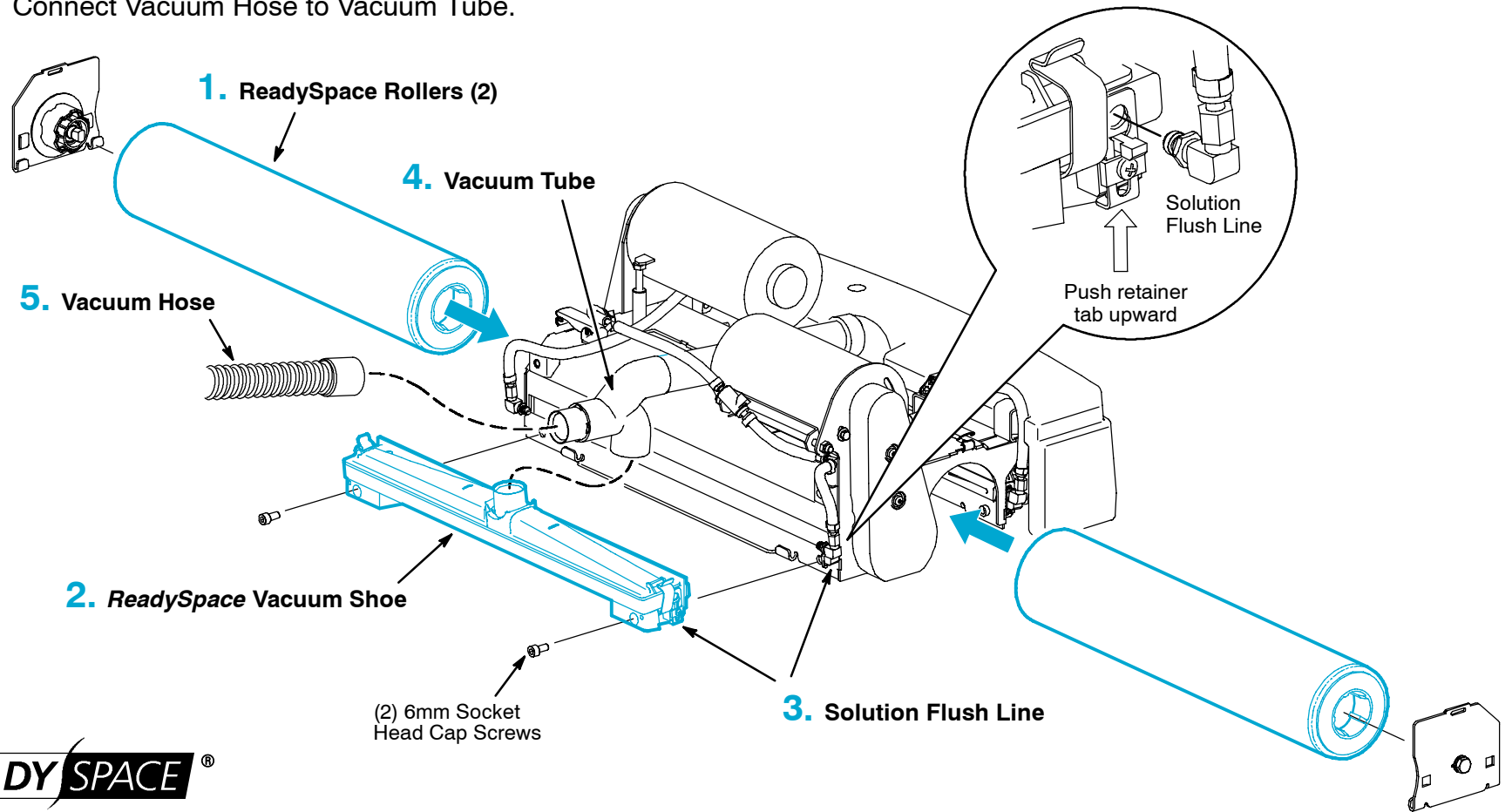
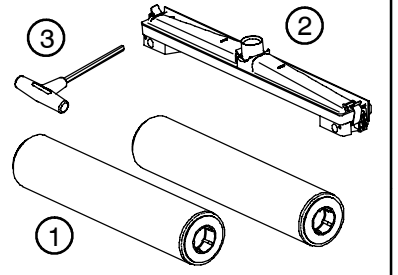

READYSPACE®

Setup

Restorative Cleaning

FOR SAFETY: Remove key from machine before performing setup procedure.

1. Install the two Restorative Brushes.
2. Install Restorative Vacuum Shoe.
3. Connect Vacuum Hose to Vacuum Shoe.

NOTE: To prevent misplacing the *ReadySpace* Vacuum Tube and Solution Flush Lines Do Not remove from Scrub Head.

Equipment Needed:

- 1) Two Restorative Brushes
- 2) Restorative Vacuum Shoe
- 3) 6 mm Hex Head Tool (supplied with machine)

